

- > Ø 2 3/4 ... 12 inch (Ø 78 ... 330 mm)
 - > Frictionless operation
 - > No maintenance or lubrication
 - > Ideal for short stroke, high-force applications
 - > High isolation level for vibrating machines
- > Very easy to install – no alignment problems



Technical features

Medium:

Compressed air lubricated or unlubricated, Nitrogen, water (with glycol)

Operation:

Single acting

Operating pressure:

5,5 bar (79 psi) recommended dynamic pressure
 8 bar (116 psi) maximum

Nominal diameters:

2 3/4, 4 1/2, 6, 8, 9 1/4, 12 inches

Strokes:

From 20 ... 320 mm max., depending on diameters and number of convolutions

Operating temperature:

for PM/31000 (Standard)
 -30 ... +50°C (-22 ... +122°F)
 -40 ... +70°C* (-40 ... +158°F)*
 IR for TPM/31000
 -20 ... +70°C (-4 ... 158°F)
 -25 ... +90°C* (-13 ... 194°F)*
 ECO for EPM/31000
 +50 ... +115°C (+122 ... 239°F)
 -20 ... +130°C* (-4 ... +266°F)*
 * The number represent the maximum permissible operating temperature. It is sutibel to operated with restriction at this temperature, the air bellow may have a reduced life time!

Materials:

End plates: Aluminium Ø 2 3/4 ... 6 inch, steel chromated Ø 8, 9 1/4, 12 inch
 Central ring: aluminium or steel chromated
 Bellow: PM/31000: fabric reinforced NR/BR, SBR-compound rubber
 TPM/31000: IR
 EPM/31000: ECO

Technical data

Model	PM/31021	PM/31022	PM/31023	PM/31041	PM/31042	PM/31043	PM/31061	PM/31062
Cylinder Ø [inch]	2 3/4"	2 3/4"	2 3/4"	4 1/2"	4 1/2"	4 1/2"	6"	6"
Air Port	G 1/4	G 1/4	G 1/4	G 3/8	G 3/8	G 3/8	G 1/2	G 1/2
Nominal Ø (inch) x convolutions	2 3/4" x 1	2 3/4" x 2	2 3/4" x 3	4 1/2" * 1	4 1/2" * 2	4 1/2" * 3	6" x 1	6" x 2
Stroke [mm]	20	45	60	40	85	100	55	115
Installation height min [mm]	50	65	80	50	65	100	55	80
Recomended max working height [mm]	65	105	130	80	135	180	100	170
Installation height max [mm]	70	110	140	90	150	200	110	190
Retracting force to reach min height [N]	200	310	300	200	240	140	200	220
Force at 6 bar [N] depending from the stroke	See graph on page 5 & 6							

Model	PM/31063	PM/31081	PM/31082	PM/31091	PM/31092	PM/31121	PM/31122	PM/31123
Cylinder Ø [inch]	6"	8"	8"	9 1/4"	9 1/4"	12"	12"	12"
Air Port	G 1/2	G 3/4	G 3/4	G 3/4	G 3/4	G 3/4	G 3/4	G 3/4
Nominal Ø (inch) x convolutions	6" x 3	8 x 1	8 x 2	9 1/4 x 1	9 1/4 * 2	12" x 1	12" x 2	12" x 3
Stroke [mm]	190	95	185	105	230	129	230	320
Installation height min [mm]	100	55	80	55	80	51	75	110
Recomended max working height [mm]	255	140	250	150	295	151	265	395
Installation height max [mm]	285	150	265	160	310	180	305	430
Retracting force to reach min height [N]	250	60	110	150	170	300	300	400
Force at 6 bar [N] depending from the stroke	See graph on page 5 & 6							

Alternative air bellows

Symbol	Model	Material	Description	Dimension see page
	PM/31000	Standard	Ø 2 3/4 ... 12 inches (78 ... 310 mm)	3 and 4
	TPM/31000	IR	Ø 2 3/4 ... 12 inches (78 ... 310 mm)	3 and 4
	EPM/31000	ECO	Ø 2 3/4 ... 12 inches (125 ... 310 mm)	3 and 4

Options selector

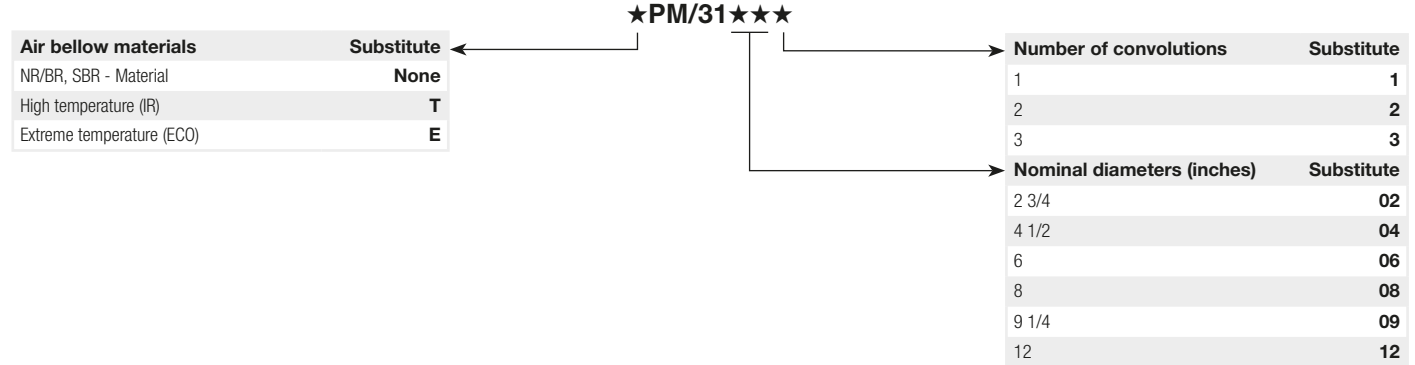

Note: Please fill in only the numbers of digits required, e.g. PM/31023



Important instructions:

Thrust:

The thrust depends on the height of the bellow. When height increases - the thrust decreases.

- Before installing the air bellow, check it carefully for any damage it may have suffered from transport or improper storage.
- Do not inflate the air bellow until it has been secured properly.

Clearance:

There must be enough clearance around the air bellow.

- The full surface of the metal parts is to be used to bear the forces.
- Air bellows must be equipped with lateral guides.
- Deflate the air bellows fully before removing.
- Ensure that the bellows is not constantly in contact with hydraulic oil, lubricants, solvents, metal cuttings and welding sparks.
- Should the air bellow be subjected to special media in an application, ask Norgren for further information, specifying the medium, temperature and concentration

Stops:

To avoid damage when the bellow is compressed or extended mechanical stops at both end positions have to be used.

Dimensions

PM/31021,
PM/31022,
PM/31023

Dimensions in mm
Projection/First angle

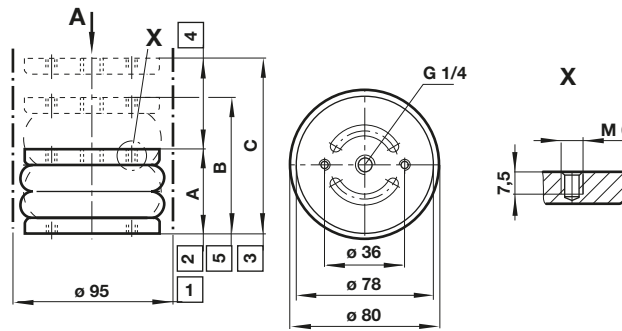

- 1 Installation diameter min.
- 2 Installation height min.
- 3 Installation height max.
- 4 Stroke
- 5 Recommended max. working height

Table 1

Nominal Ø (inch) x convolutions	Stroke (mm)	Installation height [A] min. (mm)	Recommended working height [B] max. (mm)	Installation height [C] max. (mm)	Max. torque for mounting studs (Nm)	Natural frequency [fn] at 4 bar (Hz)	Siffness at 4 bar (N/mm)	Recommended vibration height [mm]	Weight (kg)	Model
2 3/4" x 1	20	50	65	70	5	5,3	131	60	0,35	PM/31021
2 3/4" x 2	45	65	105	110	5	3,65	49,4	90	0,4	PM/31022
2 3/4" x 3	60	80	130	140	5	—	—	—	0,5	PM/31023

PM/31041,
PM/31042,
PM/31043

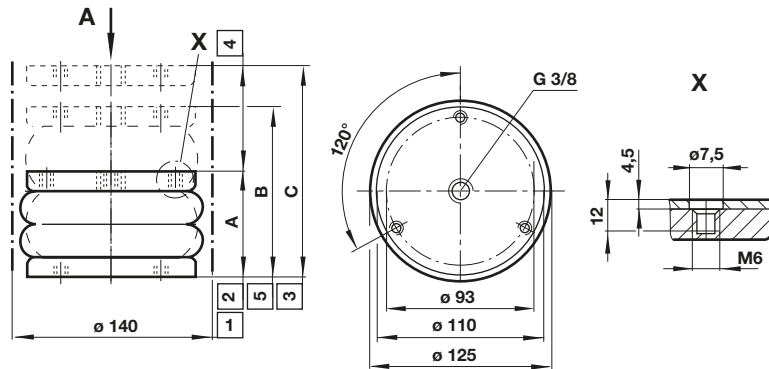

- 1 Installation diameter min.
- 2 Installation height min.
- 3 Installation height max.
- 4 Stroke
- 5 Recommended max. working height

Table 1.1

Nominal Ø (inch) x convolutions	Stroke (mm)	Installation height [A] min. (mm)	Recommended working height [B] max. (mm)	Installation height [C] max. (mm)	Max. torque for mounting studs (Nm)	Natural frequency [fn] at 4 bar (Hz)	Siffness at 4 bar (N/mm)	Recommended vibration height [mm]	Weight (kg)	Model
4 1/2" x 1	40	50	80	90	5	3,96	148	70	0,75	PM/31041
4 1/2" x 2	85	65	135	150	5	2,85	86	130	0,95	PM/31042
4 1/2" x 3	100	100	180	200	5	—	—	—	1,2	PM/31043

PM/31061,
PM/31062,
PM/31063

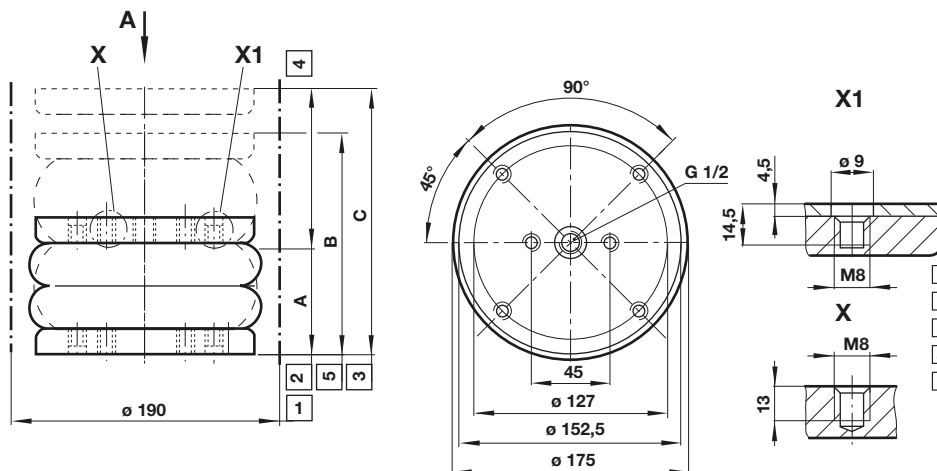

- 1 Installation diameter min.
- 2 Installation height min.
- 3 Installation height max.
- 4 Stroke
- 5 Recommended max. working height

Table 1.2

Nominal Ø (inch) x convolutions	Stroke (mm)	Installation height [A] min. (mm)	Recommended working height [B] max. (mm)	Installation height [C] max. (mm)	Max. torque for mounting studs (Nm)	Natural frequency [fn] at 4 bar (Hz)	Siffness at 4 bar (N/mm)	Recommended vibration height [mm]	Weight (kg)	Model
6" x 1	55	55	100	110	12	3,75	283	90	2	PM/31061
6" x 2	115	80	170	190	12	2,26	92,5	160	2,7	PM/31062
6" x 3	190	100	255	285	12	—	—	—	3	PM/31063

**Dimensions
PM/31081,
to PM/31123**

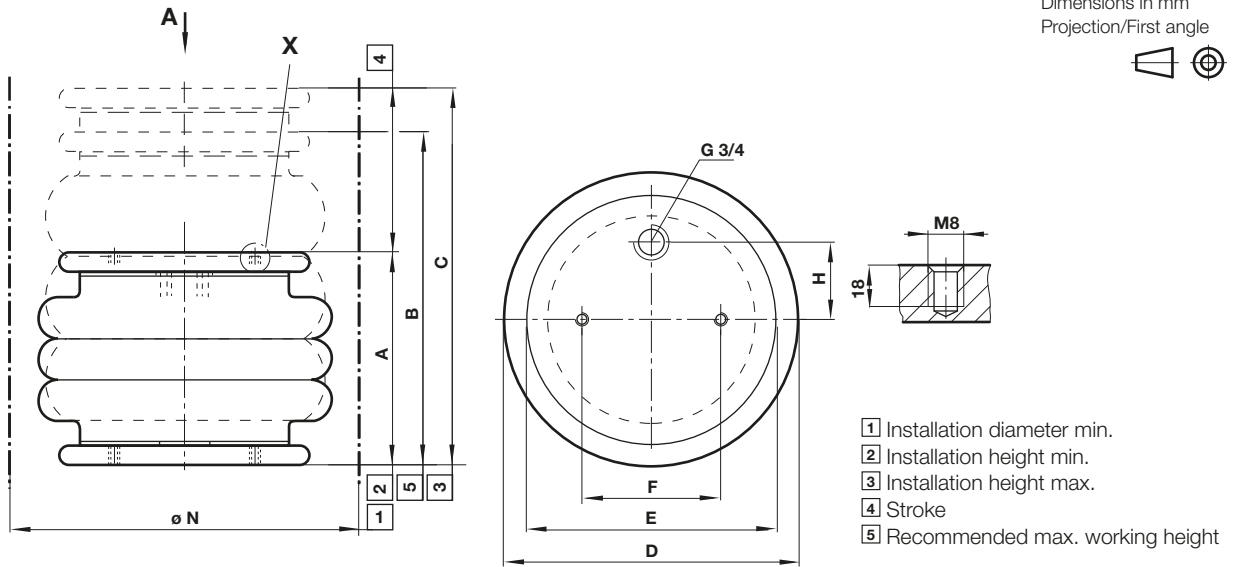
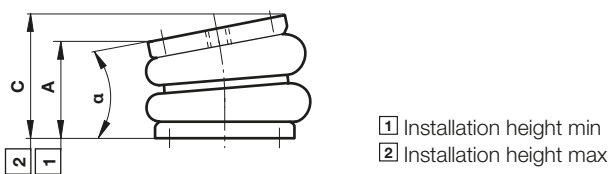

Table 1.3

Nominal Ø (inch) x convolutions	Stroke (mm)	Installation height [A] min. (mm)	Recommended working height [B] max. (mm)	Installation height [C] max. (mm)	Max. torque for mounting studs (Nm)	Natural frequency [fn] at 4 bar (Hz)	Siffness at 4 bar (N/mm)	Recommended vibration height [mm]	Ø E	Ø D	Ø F	H	Ø N	Weight (kg)	Model
8" x 1	95	55	140	150	12	2,54	185	140	133	225	70	—	240	1,8	PM/31081
8" x 2	185	80	250	265	12	1,93	87,63	205	133	220	70	—	240	2,3	PM/31082
9 1/4" x 1	105	55	150	160	12	2,25	200	110	155	225	89	38	275	2,3	PM/31091
9 1/4" x 2	230	80	295	310	12	1,64	95,8	220	155	225	89	38	275	3,1	PM/31092
12" x 1	129	51	151	180	25	2,3	332	140	228	343	157,5	73	360	4,3	PM/31121
12" x 2	230	75	265	305	25	1,9	190	240	228	325	157,5	73	340	4,8	PM/31122
12" x 3	320	110	395	430	25	—	—	—	228	325	157,5	73	345	5,9	PM/31123

Operation angle



Out of alignment

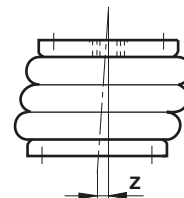

Table 2

Nominal Ø (inch) x convolutions	Operating angle [α] max. (°)	Out of alignment [Z] max. (mm)	Installation height [A] min. (mm)	Installation height [C] max. (mm)	Model
2 3/4" x 1	—	—	50	70	PM/31021
2 3/4" x 2	10	10	65	110	PM/31022
2 3/4" x 3	10	10	80	140	PM/31023
4 1/2" x 1	5	5	50	90	PM/31041
4 1/2" x 2	10	10	65	150	PM/31042
4 1/2" x 3	10	10	100	200	PM/31043
6" x 1	10	10	55	110	PM/31061
6" x 2	10	10	80	190	PM/31062
6" x 3	10	10	100	285	PM/31063
8" x 1	10	10	55	150	PM/31081
8" x 2	10	10	80	265	PM/31082
9 1/4" x 1	10	10	55	160	PM/31091
9 1/4" x 2	10	10	80	310	PM/31092
12" x 1	10 ... 20	10	51	180	PM/31121
12" x 2	15 ... 25	20	75	305	PM/31122
12" x 3	15 ... 30	30	110	430	PM/31123

Operation angle

Tilt angles from 5 ... 30° are possible, depending on the air bellow design.

Ensure application is within minimum and maximum installation heights.

Thrust (at 2, 4, 6, 8 bar), volume (at 6 bar)

PM/31021

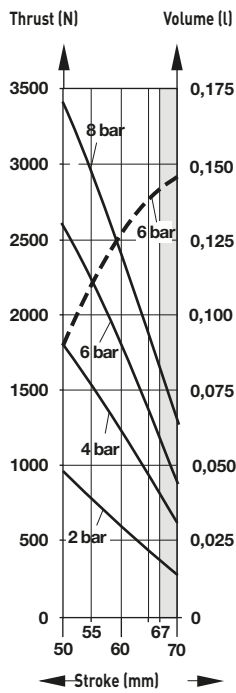

PM/31022

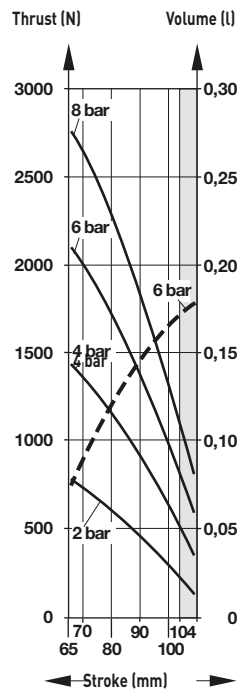

PM/31023

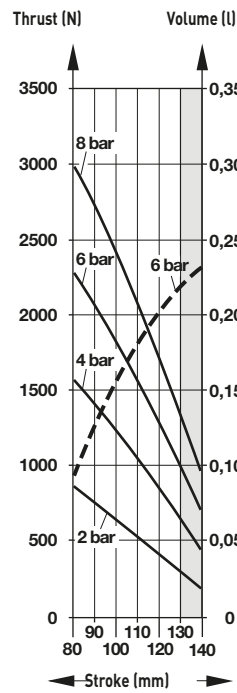

PM/31041

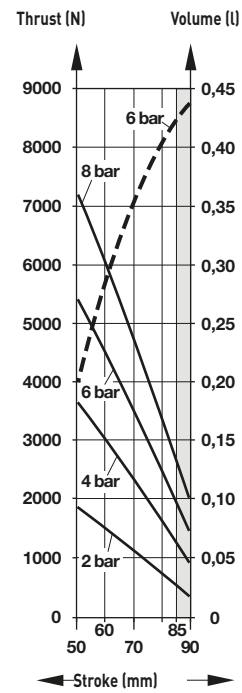

PM/31042

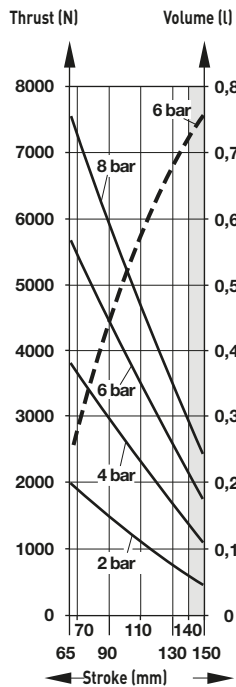

PM/31043

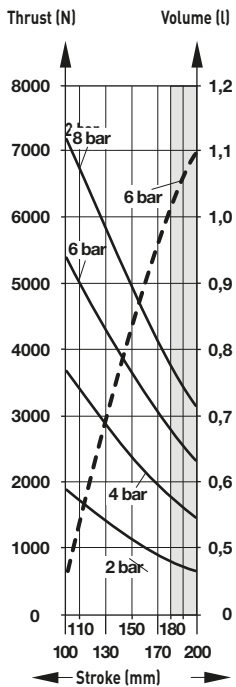

PM/31061

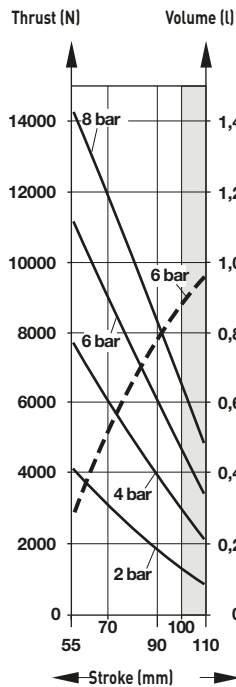

PM/31062

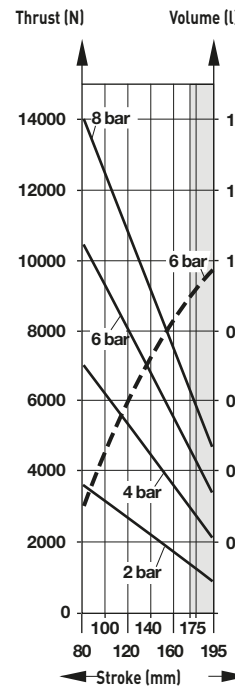

PM/31063

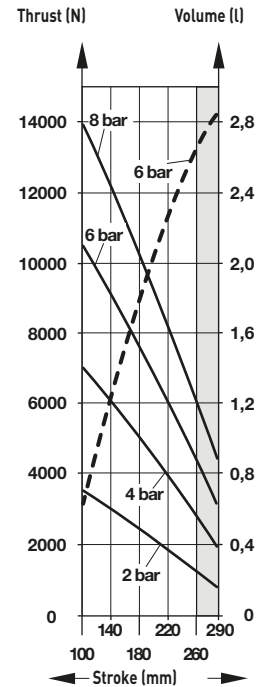

— Thrust (N) - - - Volume (l)

Caution!

Ensure that all applications are within the max. installation height. For applications in the grey area please contact Norgren technical service.

Thrust (at 2, 4, 6, 8 bar), volume (at 6 bar)

PM/31081

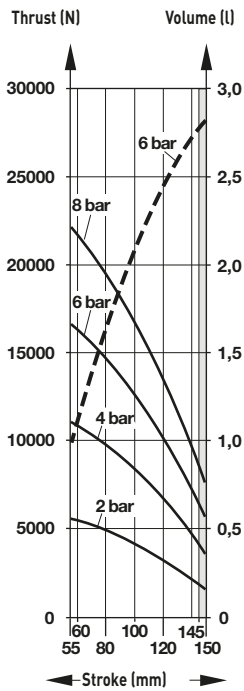

PM/31082

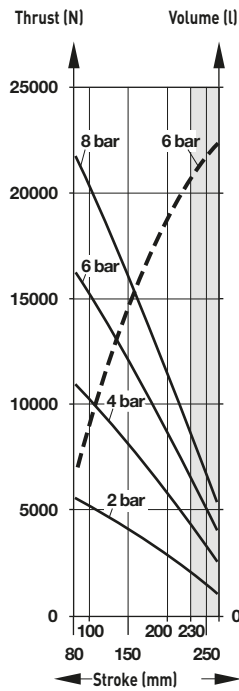

PM/31091

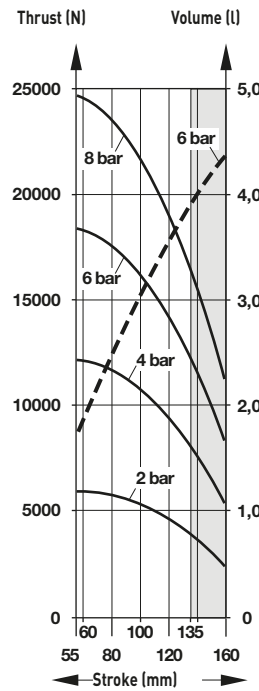

PM/31092

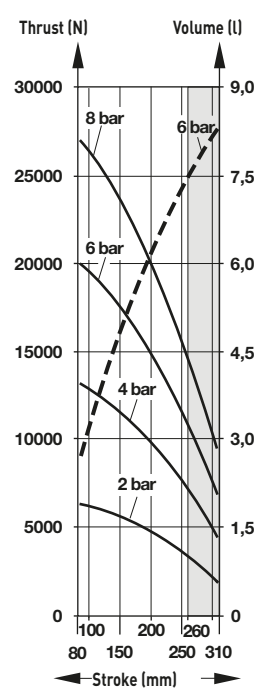

PM/31121

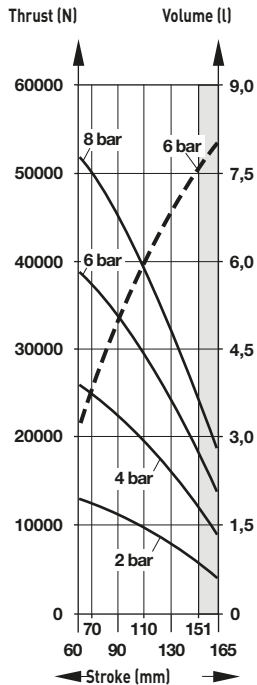

PM/31122

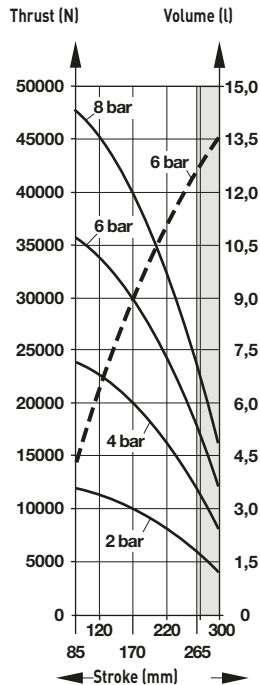

PM/31123

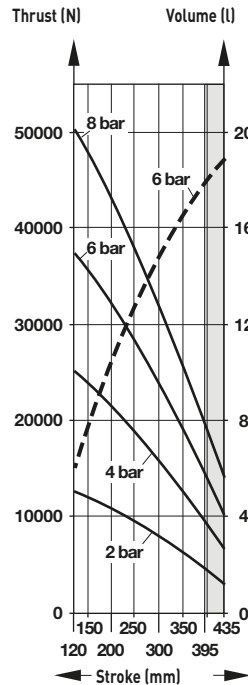

— Thrust (N) -- Volume (l)

Caution!

Ensure that all applications are within the max. installation height. For applications in the grey area please contact Norgren technical service.

Application example - Air bellow as an actuator

A 1000 kg conveyor carrying a 550 kg pallet needs to be lifted by 90 mm (stroke) in order to transfer the pallet to another level. Four (4) air bellows should be used. The available operating pressure is 5 bar.

The operating temperature is 50°C. There is a 270 mm square space to house each air bellow. Compression and extension stops are provided. The air bellows have to be mounted between in a space which are 85 mm apart. During the lifting operation the conveyor may tilt in the second half of the stroke by a max. of 9°.

Step 1: Fill in and complete the datasheet

a) Total weight to be lifted:	F = (1000 kg + 550 kg) x 10 m/s ² = 15500 N
b) Number of air bellows:	n = 4
c) Thrust per air bellow:	f = $\frac{15500 \text{ N}}{4} = 3875 \text{ N}$
d) Operating pressure:	P = 5 bar
e) Required stroke:	S = 90 mm
f) Vertical space:	Xv = 85 mm
g) Horizontal space:	Xh = 270 mm
h) Operating temperature:	T = 50°C
i) Operation angle:	a = 9°
j) Out of alignment:	A = 0 mm
k) Chemical resistance:	normal environment

Step 2:

From table 1.1 ... 1.3 air bellows have to be selected, that have a stroke of 90 mm and clearance around the air bellows smaller than Xh = 270 mm. We select: PM/31043, PM/31062, PM/31063, PM/31081 and PM/31082

Step 3:

Calculate the total height at which the air bellow should be used,
 Vertical space Xv 85 mm
 Stroke S 90 mm
 Total height 175 mm

By referring to the total height of 175 mm and the vertical space of 85 mm

PM/31062 Installation height [A] min = 80 mm
 Installation height (C) max = 190 mm

and

PM/31082 Installation height [A] min = 80 mm
 Installation height (C) max = 265 mm
 can be used from table 1.2 & 1.3

Step 4:

Check the thrust at 5 bar at a height of 175 mm.
 From the charts in the datasheet 5 & 6 we can see that:

PM/31062

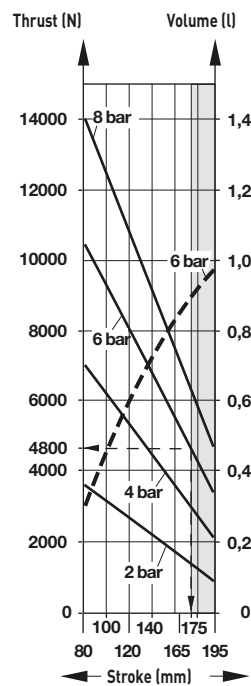

PM/31062 will provide 4800 N at 6 bar. To get the figure for 5 bar, we have to calculate:

$$\frac{4800 \text{ N} \times 5}{6} = 4000 \text{ N at 5 bar}$$

Result:

Both air bellows can provide the required thrust of 3875 N. But the PM/31062 is still working on the critical zone and force can drop done via pressure issue. Please select the bigger one PM/31082.

Step 5:

Check the operation angel and the out of alignment when the selected air bellow can tilt, see table 2.

- i) max. operation angle 10° is higher as existing operating angel 9°.
- j) max. out of alignment is 10 mm is higher as existing alignment 0 mm.

Result:

PM/31082 can be used.

Step 6:

Check all remaining parameters

- h) At 50°C Standard rubber material -30 ... + 50°C
- k) No special chemical resistance is required

Result:

PM/31082 is the chosen air bellow, because it meets all requirements.

PM/31082

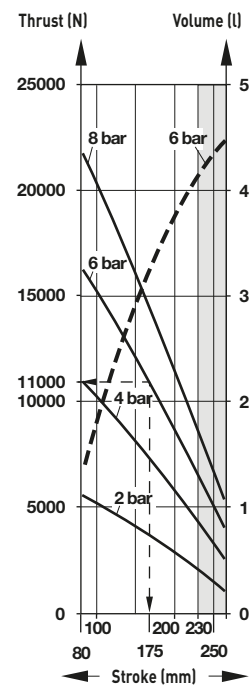

PM/31082 will provide 11500 N at 6 bar. To get the figure for 5 bar, we have to calculate:

$$\frac{11000 \text{ N} \times 5}{6} = 9166 \text{ N at 5 bar}$$

Application example - Air bellow as a vibration isolator Step 4:

A hydraulic power unit with an excitation frequency (f_e) between 1200 and 3000 cycles/min. (= 20 to 50 Hz) must be vibration isolated. The total weight of the power unit is 3000 kg. The supporting area under the unit is 1,2 m x 0,8 m. The operating temperature is 50°C. The space for the installation is 220 mm high. Four air bellows will be used. The max. operating pressure is 4 bar. A minimum of 97% vibration isolation has to be reached.

Step 1: Fill in and complete the datasheet

a) Total weight to be isolated:	F = 3000 kg x 10 m/s ² = 30000 N
b) Number of air bellows:	n = 4
c) Thrust per air bellow:	f = $\frac{30000 \text{ N}}{4} = 7500 \text{ N}$
d) Operating pressure:	P = 4 bar
f) Vertical space:	Xv = 240 mm
g) Horizontal space:	Xh = 400 mm (0,8 m /2)
h) Operating temperature:	T = 50°C
k) Chemical resistance:	normal environment
m) Minimum isolation rate:	I = 97%
p) Excitation frequency	f_e = min. 20 Hz, max. 50 Hz

Two types of air bellows are chosen. Each one has to work with a vibration height lower than 240 mm and fit in a horizontal space smaller than 400 mm. From table 1 we select:

1. PM/31092 - Vibration height = 220 mm - Clearance around the air bellow = 275 mm - Airspring natural frequency "fn" at 4 bar = 1,64 Hz - Stiffness at 4 bar = 95,8 N/mm
2. PM/31122 - Vibration height = 220 mm - Clearance around the air bellow = 340 mm - Airspring natural frequency "fn" at 4 bar = 1,9 Hz - Stiffness at 4 bar 190 N/mm

Step 2:

Take the air bellow with the lowest airspring natural frequency $f_n = 1,64 \text{ Hz}$ and the lowest stiffness at 95,8 N/mm in order to get the highest isolation rate referring to $f_e \text{ min.} = 20 \text{ Hz}$.
Air bellow PM/31092 is chosen.

Step 3:

Calculate the isolation rate (I) of the PM/31092 by using the formula:

Formula:

$$I = 1 - \frac{1}{\left(\frac{f_e}{f_n}\right)^2 - 1}$$

Example:

$$I = 1 - \frac{1}{\left(\frac{20}{1,64}\right)^2 - 1}$$

$$= 1 - \frac{1}{148,7} = 0,993$$

$$I = 99,3\%$$

Warning

These products are intended for use in industrial compressed air systems only. Do not use these products where pressures and temperatures can exceed those listed under

»Technical features/data«

Before using these products with fluids other than those specified, for non-industrial applications, life-support systems or other applications not within published specifications, consult IMI Precision Engineering, Norgren GmbH.

Through misuse, age, or malfunction, components used in fluid power systems can fail in various modes.

Check the thrust at 4 bar at a height of 220 mm. From the charts in the datasheet page 6 we can see that.

PM/31092

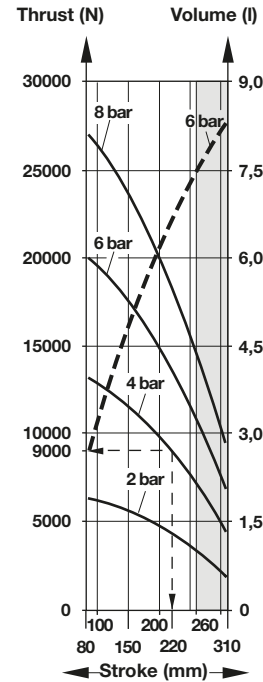

PM/31092 will provide 9000 N as a vibration height of 220 mm at 4 bar.

Step 5:

Check all remaining parameters

- h) At 50°C Standard rubber material (-30 ... +50°C) can be used.
- g) No special chemical resistance is required.

Result:

4 x PM/31092 air bellows are chosen. They will provide 99,3% vibration isolation and lift the 3000 kg weight at 4 bar.

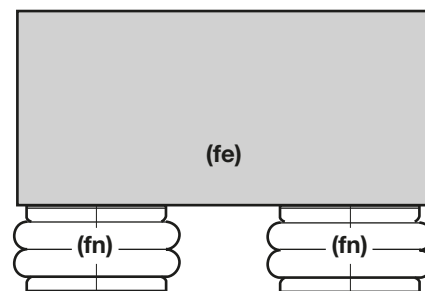

f_e = Excitation frequency of load
 f_n = Airspring natural frequency

The system designer is warned to consider the failure modes of all component parts used in fluid power systems and to provide adequate safeguards to prevent personal injury or damage to equipment in the event of such failure.

System designers must provide a warning to end users in the system instructional manual if protection against a failure mode cannot be adequately provided.

System designers and end users are cautioned to review specific warnings found in instruction sheets packed and shipped with these products.